



System Alarmowy Standard (Syrena zewnętrzna)



System Alarmowy Standard (Syrena wewnętrzna)



Instrukcja Obsługi

Dziękujemy, że wybrali Państwo System Alarmowy marki Yale. Aby w prosty sposób samodzielnie zainstalować i uruchomić system prosimy postępować zgodnie z poniższymi wskazówkami:

A) Zapoznaj się dokładnie z niniejszą instrukcją obsługi.

B) Zaplanuj swój system alarmowy, wybierz optymalne miejsca montażu elementów systemu korzystając ze wskazówek zamieszczonych w dalszej części instrukcji (system pozwala na połączenie do 20 elementów, wszystkie elementy systemu dostarczone w opakowaniu są sparowane z centralką systemu).

C) Przed zamocowaniem na stałe elementów systemu przetestuj jego działanie aby upewnić się, że jakość połączenia elementów z centralką jest wystarczająca do prawidłowego bezprzewodowego działania.

D) Po uruchomieniu systemu wyłącz alarm uszkodzenia mechanicznego syreny (znajduje się pod pokrywą syreny, rys. 4 str. 9) na 3 godziny aby zainstalować wszystkie elementy systemu. W przypadku dłuższego czasu potrzebnego do instalacji lub w przypadku konieczności wymiany baterii ponownie wyłącz alarm uszkodzenia mechanicznego syreny na 3 godziny.

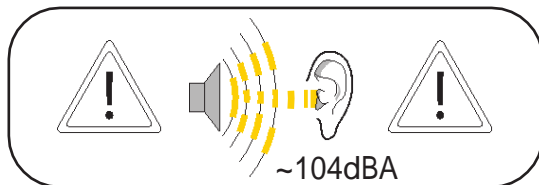

Zawartość opakowania.	(04-05)	
Jak działa alarm.	(06)	
Planowanie systemu	(07-08)	
Montaż	(9-14)	
Używanie systemu	(15-17)	
Wymiana baterii	(18 i 21)	
Akcesoria	(19)	
Parowanie dodatkowych elementów (do kupienia osobno)	(20)	
Usuwanie i resetowanie elementów	(22-23)	
Rozwiązywanie problemów	(24)	
Specyfikacja techniczna	(25)	

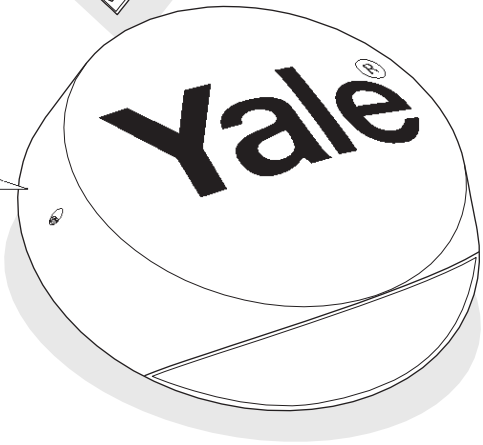
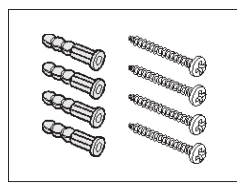
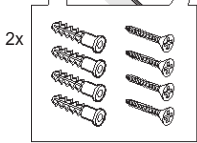
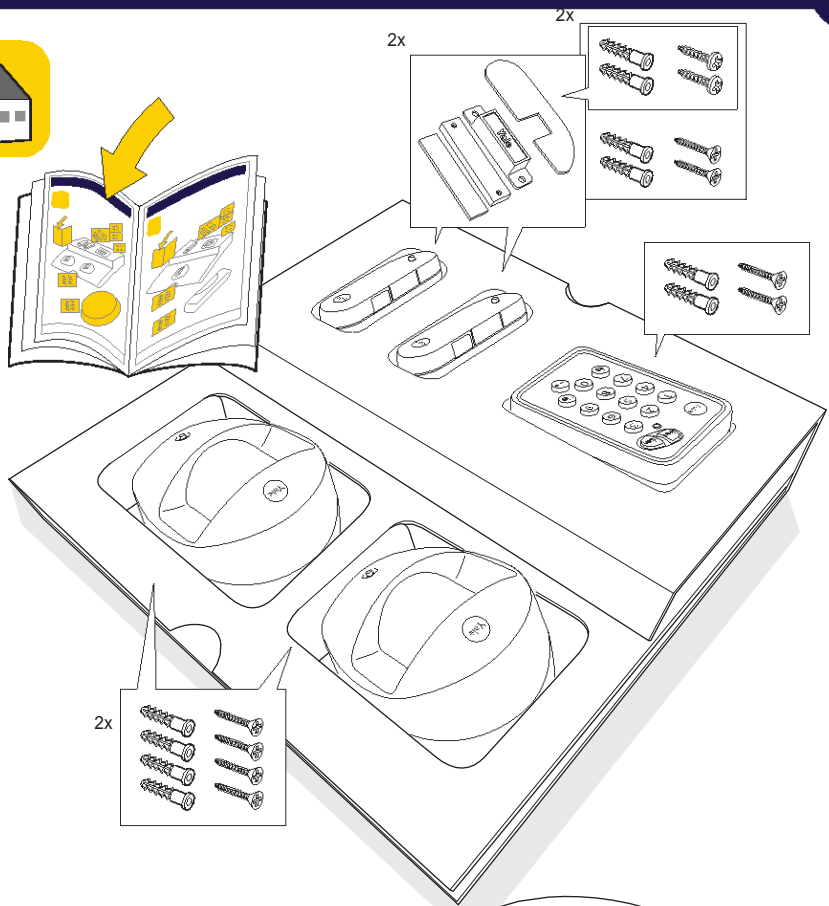

Domyślny kod PIN 0000

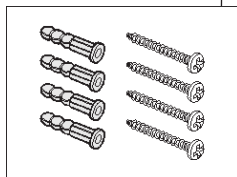
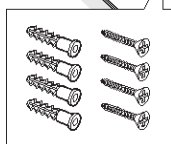
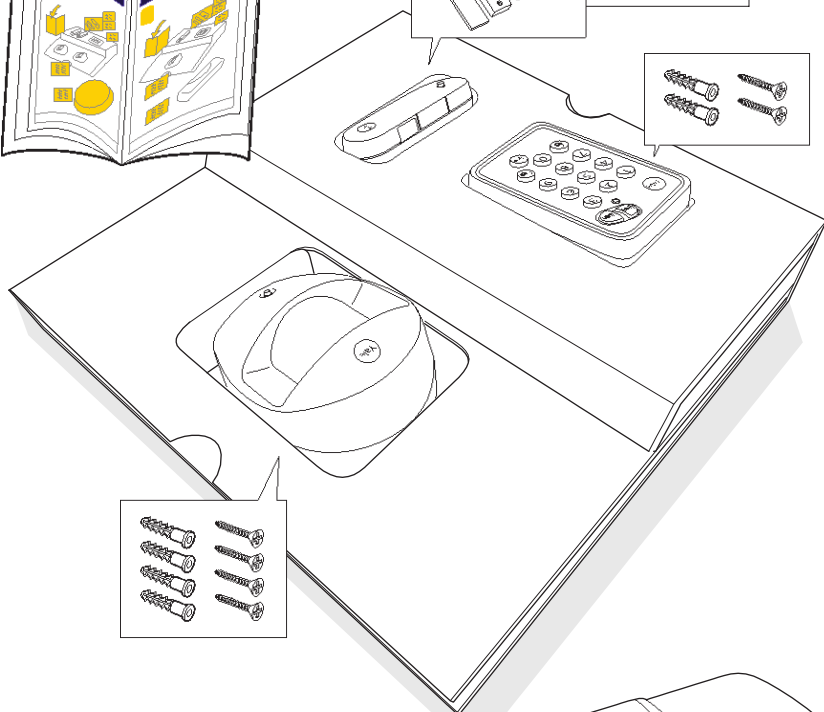
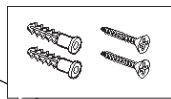
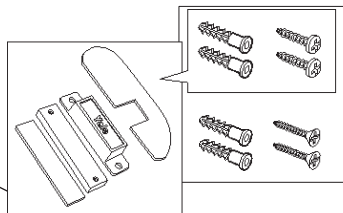

Domyślny kod PIN 0000



Czujnik drzwiowy/okienny

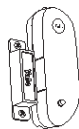

Radio 868MHz FM

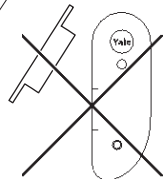
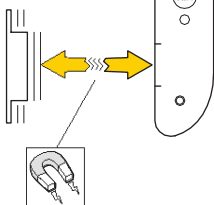
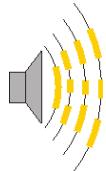

Czujnik ruchu PIR



Radio 868MHz FM

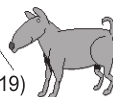
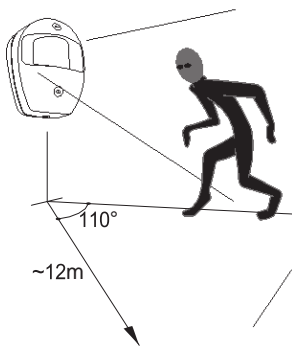
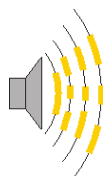

Dostępny czujnik ruchu zwierząt PIR (str. 19)

Czujnik uszkodzenia mechanicznego (zerwania)

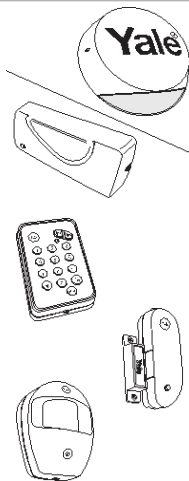

Radio 868MHz FM

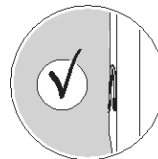
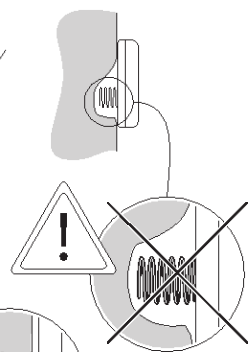
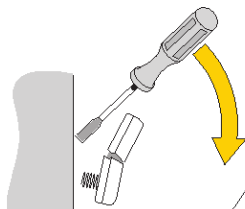
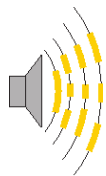



Syrena zewnętrzna

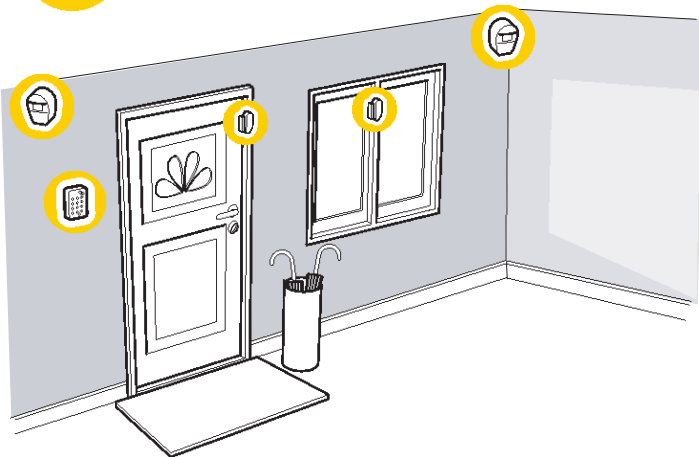

Syrena wewnętrzna

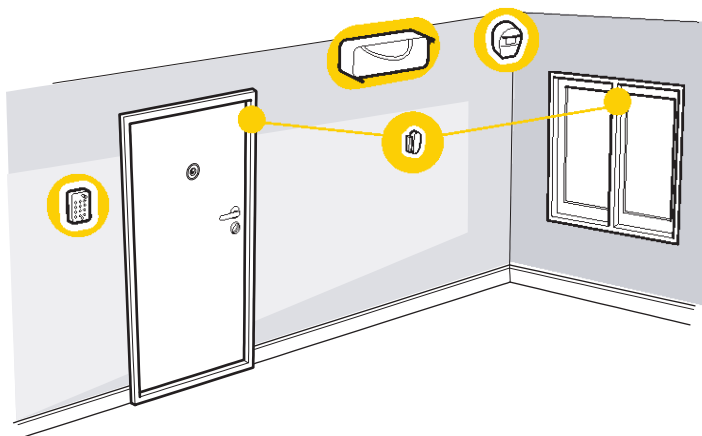



1

Zacznij montaż od syreny

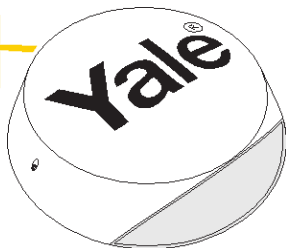

2

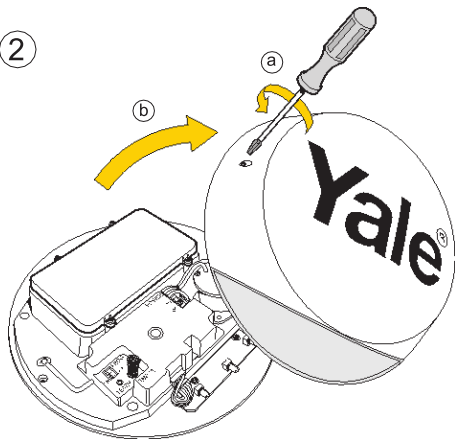

3

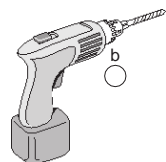

Ø 5mm

a

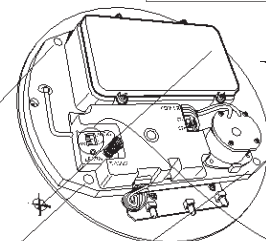

b



d

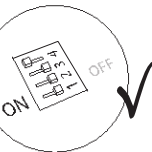

4

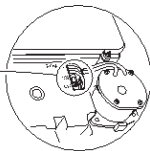
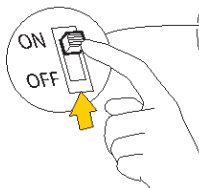

Wyłącz czujnik uszkodzenia mechanicznego



5

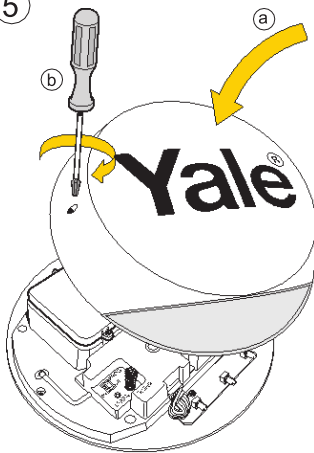

6





Zacznij montaż od syreny

1

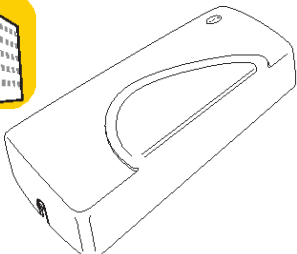

2

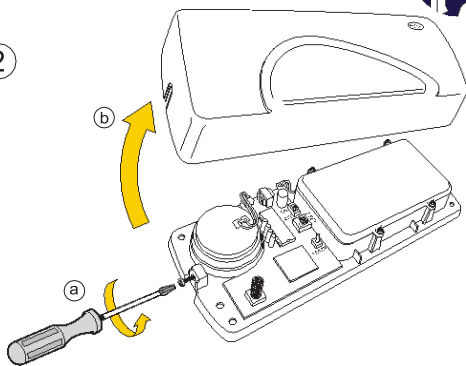

3

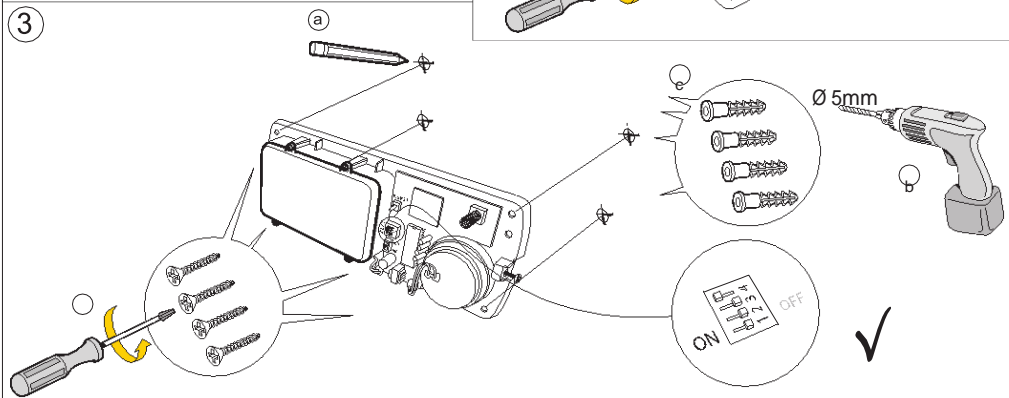

4

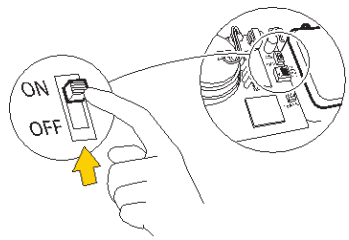

Wyłącz czujnik uszkodzenia mechanicznego



5

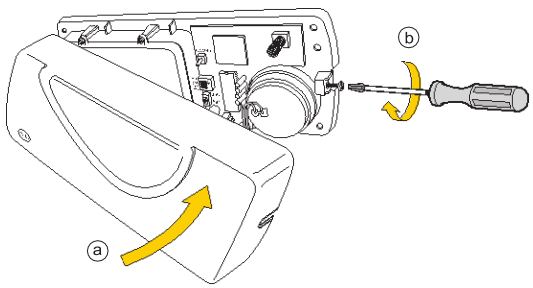

6

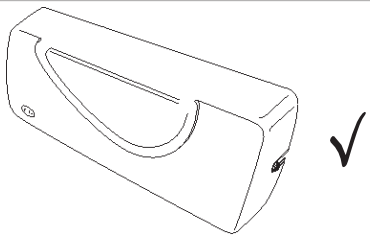



Usuń zabezpieczenie baterii

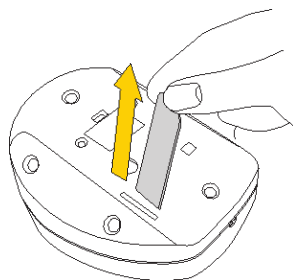
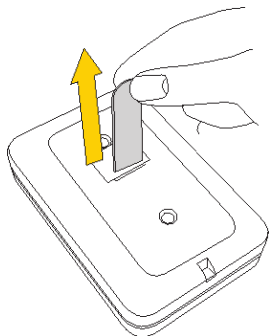
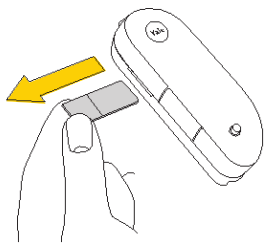

Przetestuj działanie systemu

~30 m

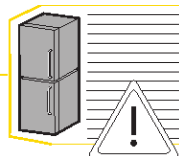
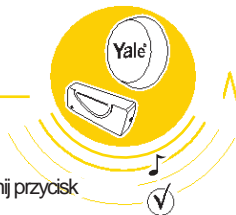

Aby sprawdzić połączenie naciśnij przycisk

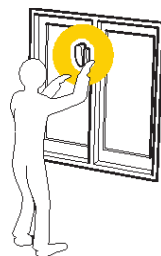
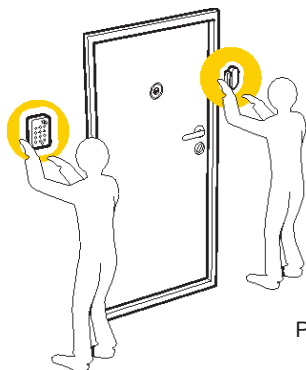
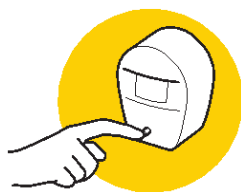
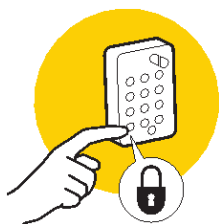

Przetestuj połączenia bezprzewodowe



1



2

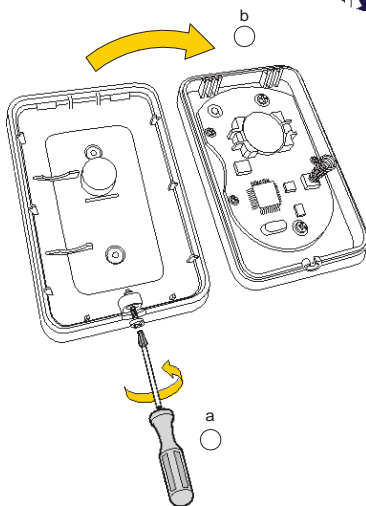

3

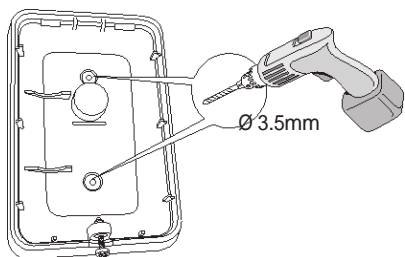

4

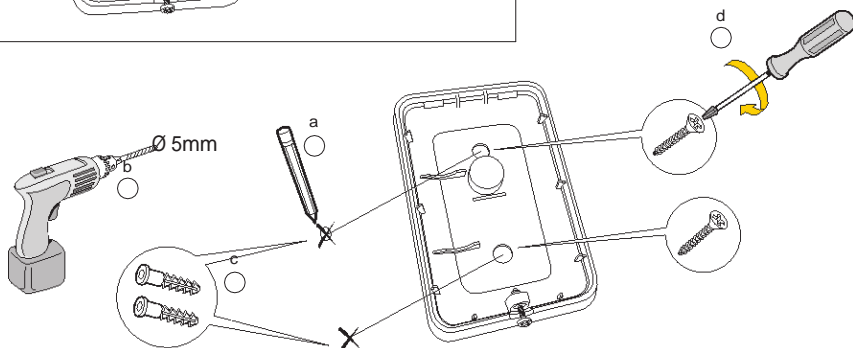

5

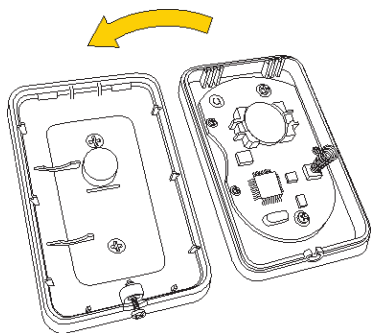

6

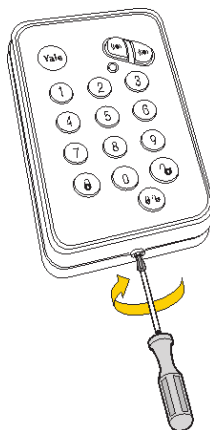



1

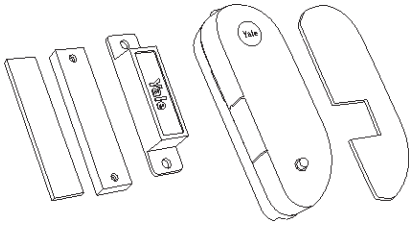

2

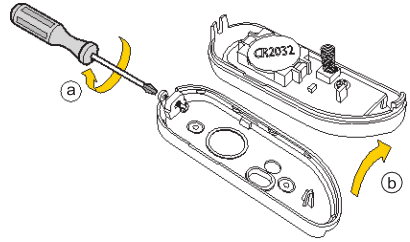

3

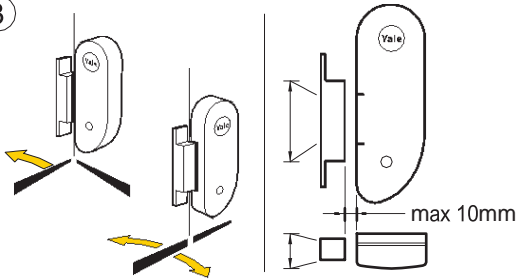

4

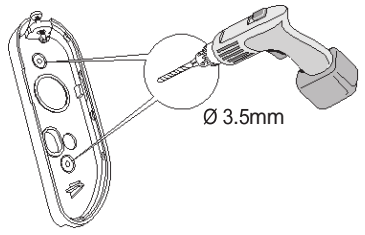

5

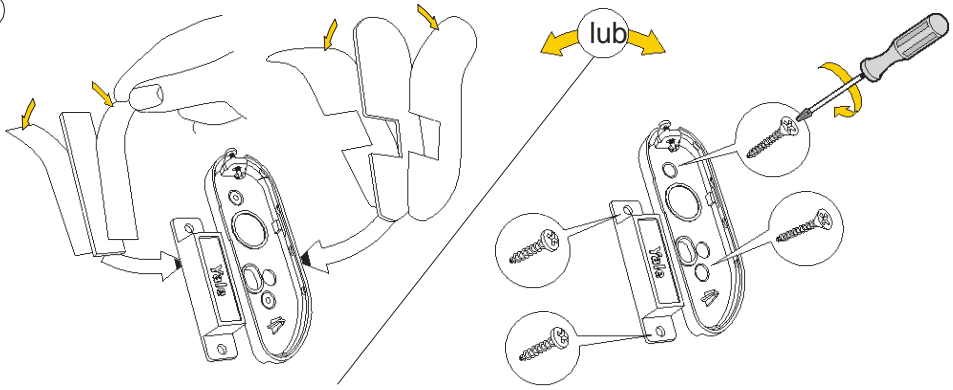

6

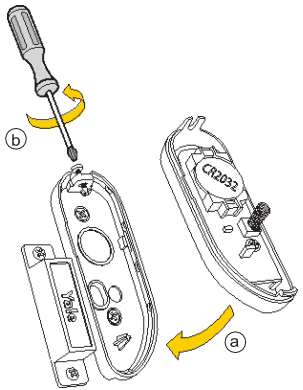

7

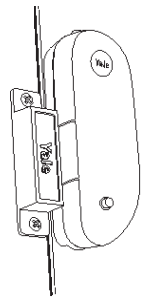

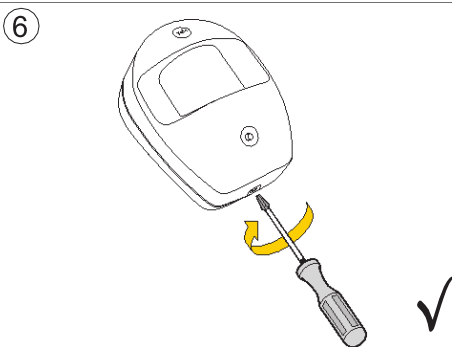
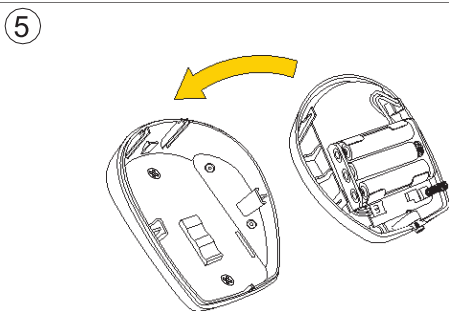
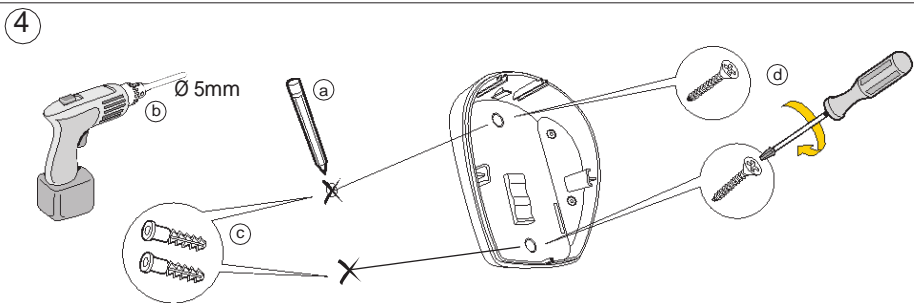
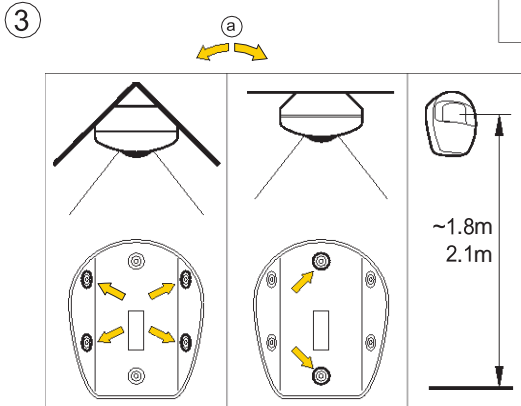
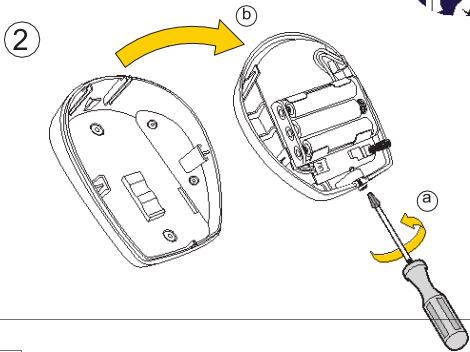
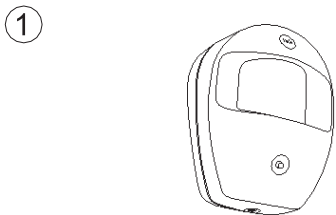

Zmiana kodu PIN

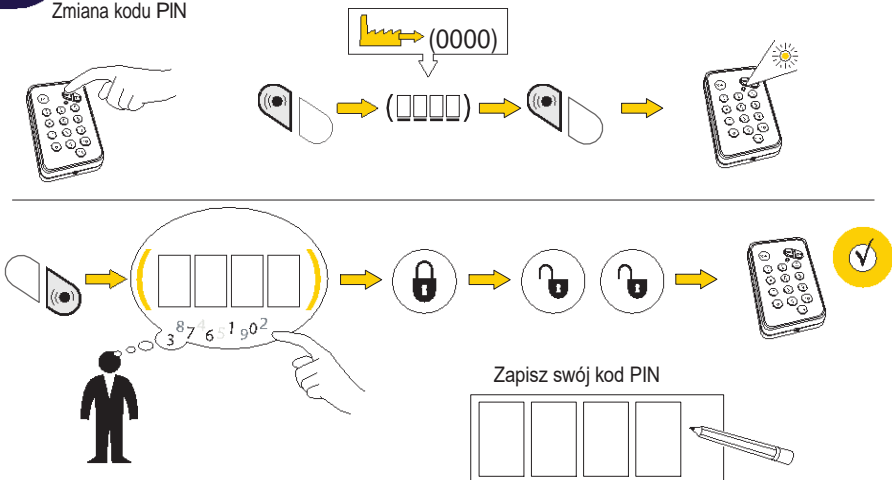

Wyjście z domu / Włączenie alarmu

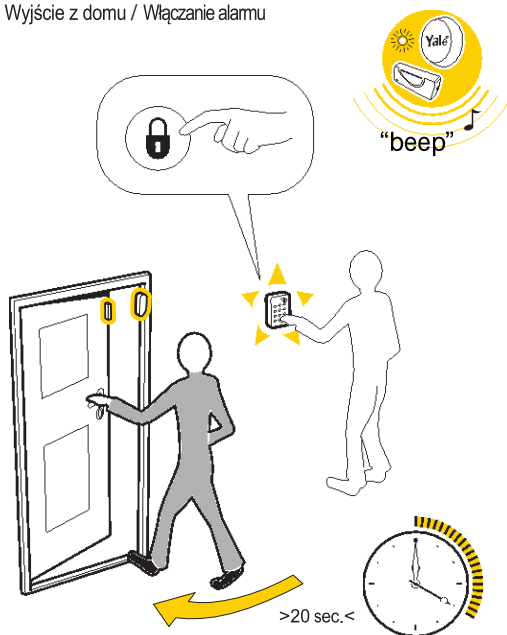

Powrót do domu / Wyłączenie alarmu

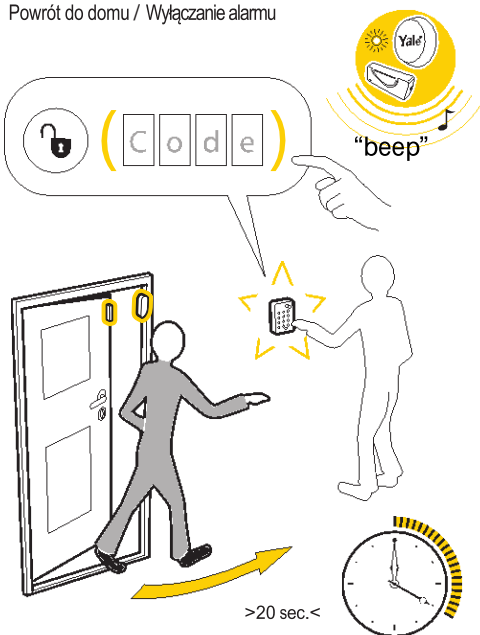



Po aktywacji syrena wyłączy się po 10 minutach

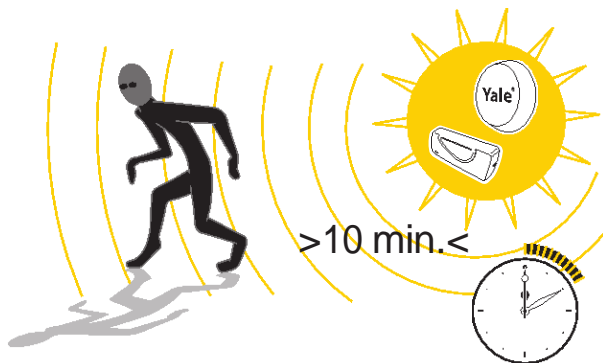

Aby wyłączyć syrenę wprowadź PIN

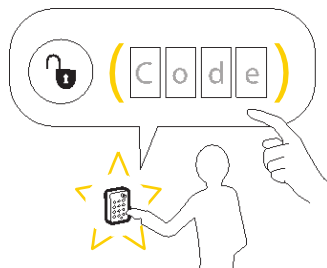

Wracając do domu po otwarciu drzwi wprowadź PIN w ciągu 20s

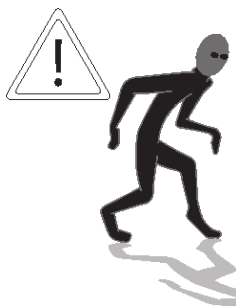
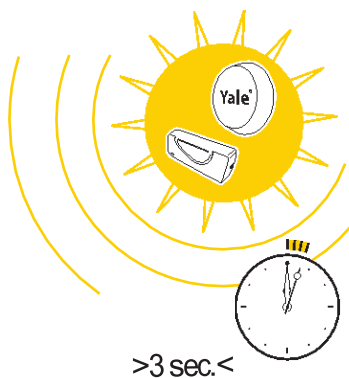
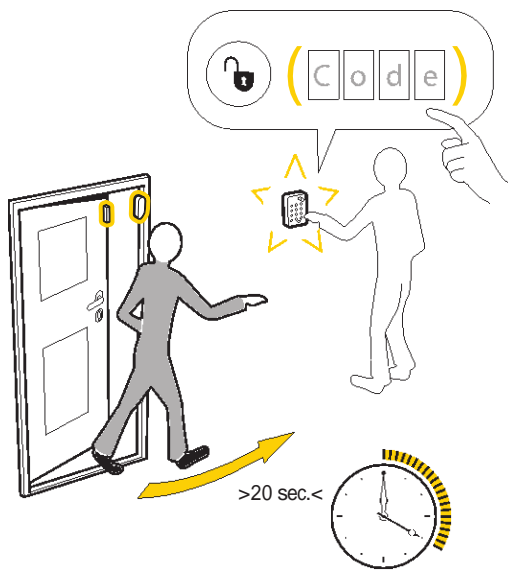

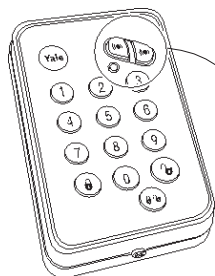

>3sec.<

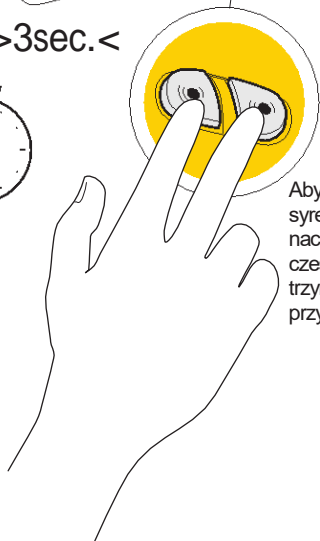

Aby uruchomić syrenę awaryjnie naciśnij jednocześnie i przytrzymaj obydwa przyciski

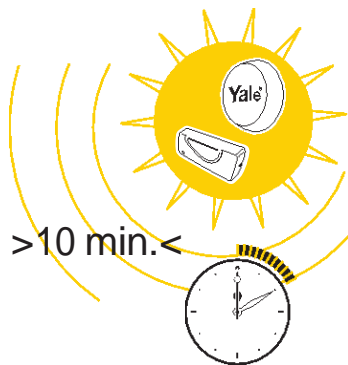

>10 min.<

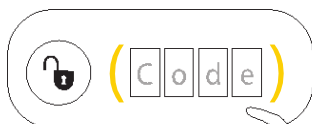
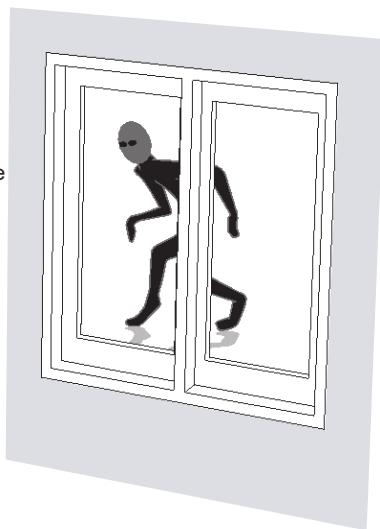

Aby wyłączyć syrenę wprowadź PIN



Wymiana baterii.



Wyładowanie baterii

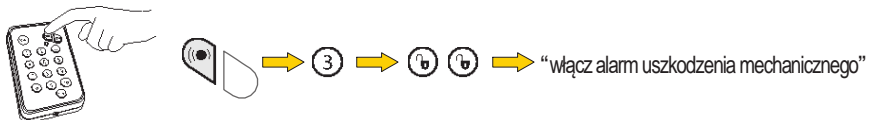
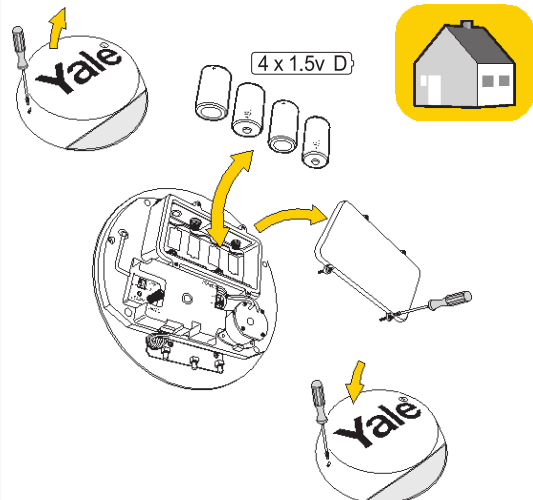
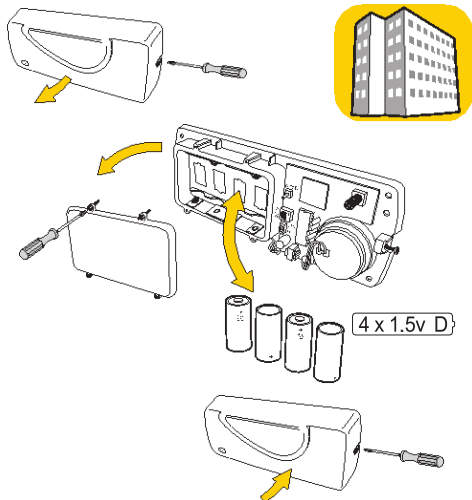
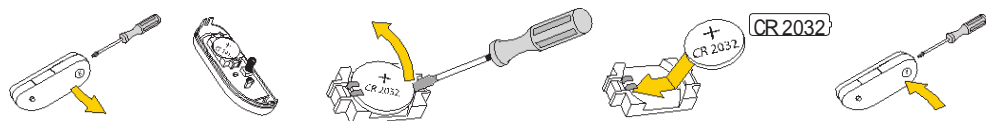
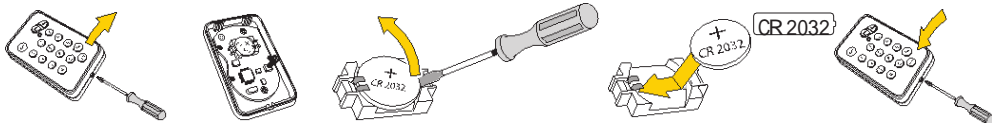
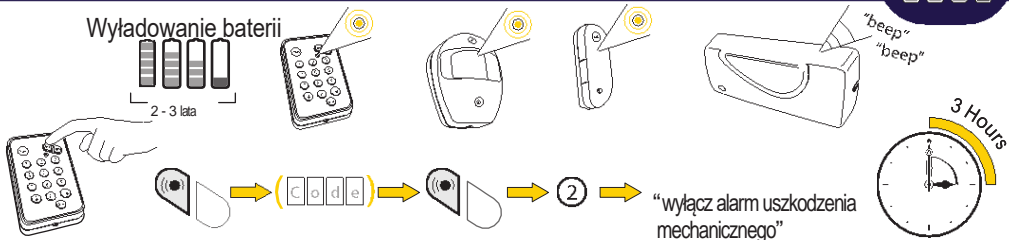



Pilot



Włączanie alarmu



Wyłączanie alarmu



Radio 868MHz FM

Czujnik dymu

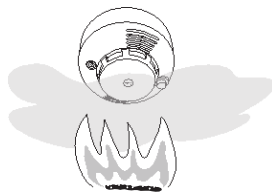
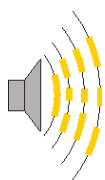
Zgodny z EN54
Radio 868MHz FM

Przycisk alarmowy

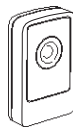

Radio 868MHz FM

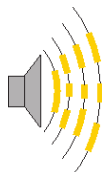

>3sec.<

Czujnik ruchu dla zwierząt
PIR (1)

Radio 868MHz FM

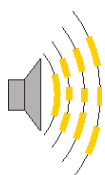
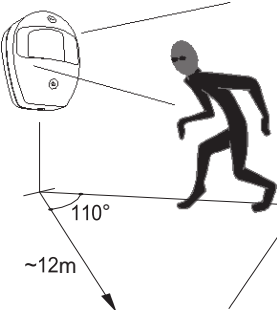
2,1m
1,8m

~12m

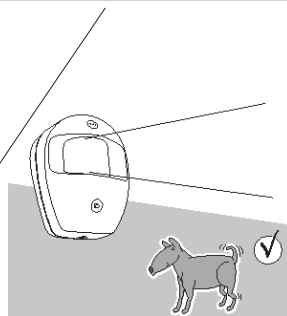

- 1) Czujnik ruchu pozwala pozostawić w domu zwierzęta przy włączonym alarmie. Dzięki temu czujnikowi alarm nie uruchomi się gdy wykryje ruch zwierzęcia a zadziała wykrywając ruch człowieka



Dodawanie nowego urządzenia

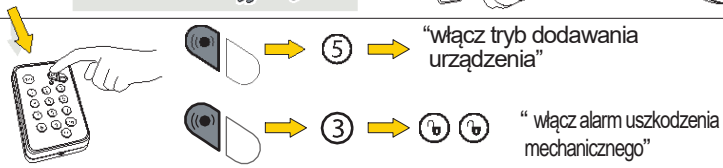
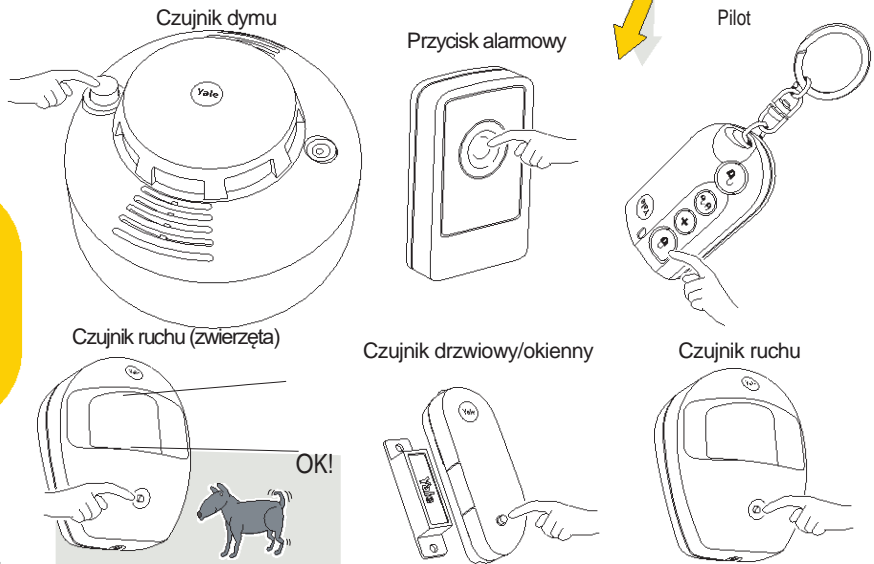
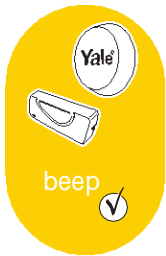
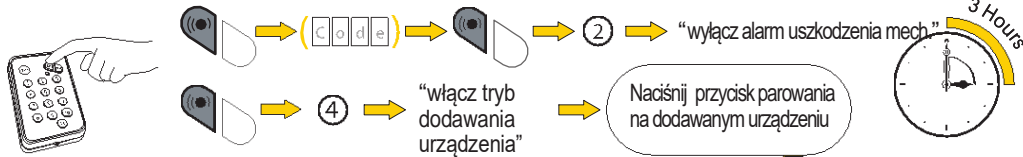

Wymiana baterii.



Wyladowanie baterii

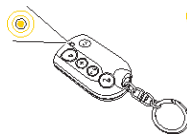
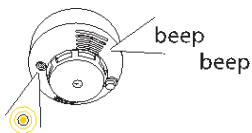

2

“wyłącz alarm uszkodzenia mechanicznego”

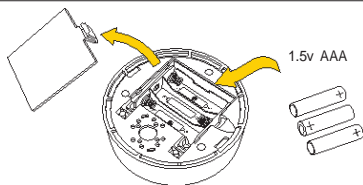
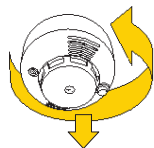

1.5v AAA

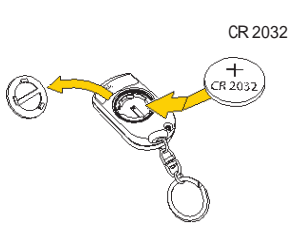
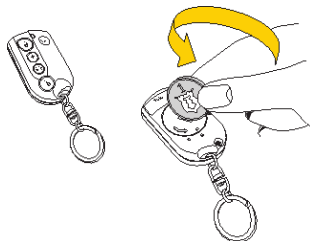
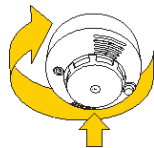

CR 2032

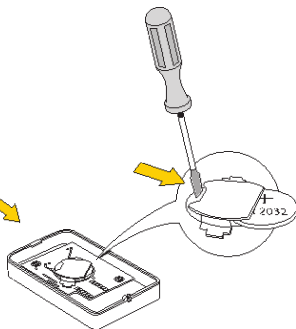
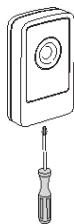

CR 2032

+ CR 2032

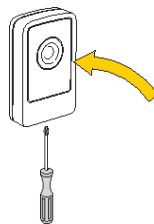

3

b

b

“włącz alarm uszkodzenia mechanicznego”

Usuwanie elementów.



2

“wyłącz alarm uszkodzenia mechanicznego”



“włącz tryb dodawania urządzenia”

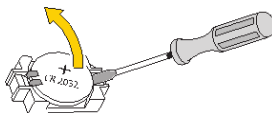

3

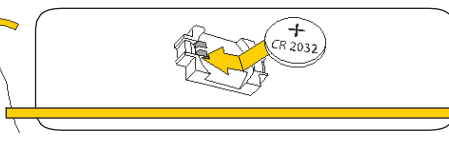

3

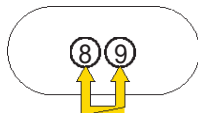

5

“wyłącz tryb dodawania urządzenia”



3

“wyłącz alarm uszkodzenia mechanicznego”



Kod PIN został usunięty, przywrócono kod fabryczny.
Ustalanie nowego kodu PIN – patrz strona 15.



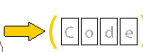

2

“wyłącz alarm uszkodzenia mechanicznego”

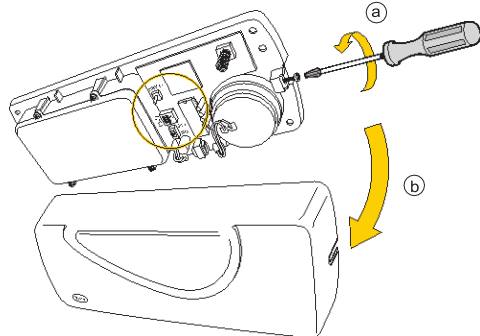
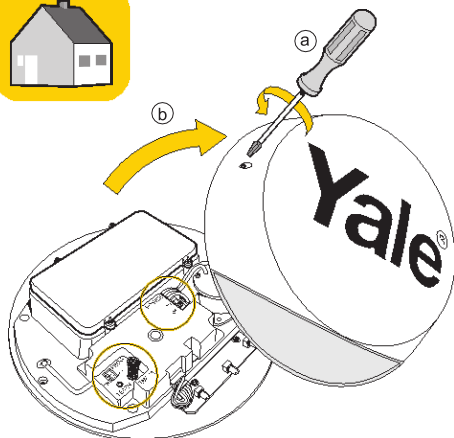

1



2



3

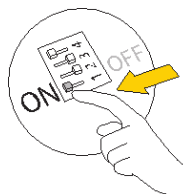

4



5



Syrena została zresetowana. Wszystkie elementy alarmu muszą być ponownie sparowane z syreną (patrz strona 20).

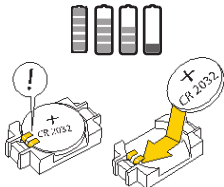

	<p>Przed demontażem pokrywy wyłącz alarm uszkodzenia mechanicznego (str. 6)</p>
<p>Test alarmu</p>	<p>Test należy wykonać dla każdego czujnika/element alarmu, jeden po drugim (nie jednocześnie).</p>
<p>Brak połączenia elementów z syreną</p>	<p>Sprawdź baterie w syrenie i w danym elemencie.</p> 
<p>Po uruchomieniu alarmu (uzbrojenie systemu) pojawia się pięciokrotny sygnał dźwiękowy.</p>	<p>Uruchomiono alarm uszkodzenia mechanicznego. Sprawdź obudowy elementów alarmu i ich mocowanie. Sprawdź baterie w syrenie.</p>
<p>Zapomniałem hasła</p>	<p>Zresetuj klawiaturę numeryczną (patrz str. 23)</p>
<p>Fałszywy alarm</p>	<p>Czujnik ruchu wykrywa gorące przedmioty, snop światła, zwierzęta domowe, pyły.</p>



ASSA ABLOY Ltd.
School Street, Willenhall
West Midlands
England, WV13 3PW

EC Declaration of Conformity

We: **ASSA ABLOY Ltd**
School Street, Willenhall
West Midlands
England, WV13 3PW

Declare under our sole responsibility that the following product(s):

Yale Model:	SR-PIR	EF-PIR
	SR-PETPIR	EF-PETPIR
	SR-DC	EF-DC
	SR-KF	EF-KF
	SR-KP	EF-KP
	SR-PB	EF-PB
	SR-SD	EF-SD
	SR-BX	EF-BX
	SR-PC	EF-BXINT
	SR-PVC	EF-PANEL
	SR-PS	EF-IPBOX
	SR-RS	EF-INTBOX
	SR-SR	EF-Easy Fit Alarm Kits
	SR-EIR	
	SR-SR	
	SR-WS	
	SR-CO	
	SR-HUB	
	SR-HUL	
	SR-HSL	
	SR-MZ8	
	SR- Smart Home Alarm kits	
	SR- Standard Alarm kits	
	SR-Smartphone Alarm kits	

Is (are) in conformity with the following relevant harmonized standards:

EN 300-220-1 / v 2.4.1 (2012)
EN 300-220-2 / v 2.4.1 (2012)
EN 301-489-1 / v 1.9.2 (2012)
EN 301-489-3 / v 1.6.1 (2012)
EN 60950-1 / 2006 + A11: 2009 + A1: 2010 + A12: 2011 + A2: 2013

Following the provisions of Council Directive 1999/5/EC on radio equipment and telecommunications terminal equipment and the mutual recognition of their conformity.

Name: **Nigel Fisher** Position: **Director**

Signature:  Date: 03/03/2016

On behalf of ASSA ABLOY Ltd.

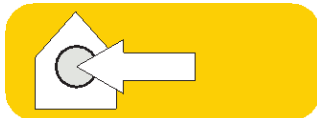

Odporność wewnętrznych urządzeń na temperaturę i wilgotność



-10°C do 40°C



70%

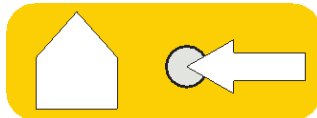

Odporność syreny zewnętrznej na temperaturę i wilgotność



-20°C do 50°C



95%



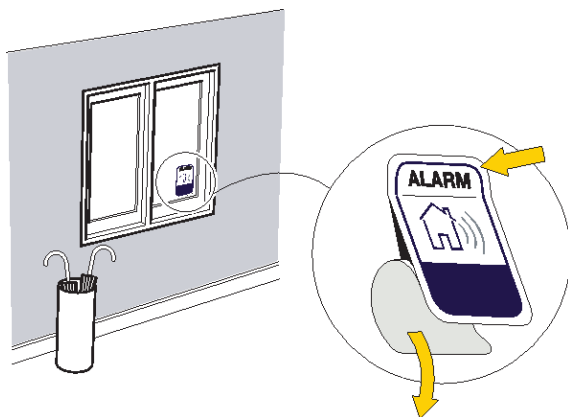

RoHS

Marka YALE jako światowy lider zabezpieczeń dostarcza unikalnych rozwiązań dla użytkowników na całym świecie.

ASSA ABLOY GROUP jest wiodącym na świecie producentem i dostawcą rozwiązań w dziedzinie zabezpieczeń, przeznaczonych do zaspokajania potrzeb użytkownika końcowego w zakresie bezpieczeństwa i wygody.

An ASSA ABLOY Group brand

ASSA ABLOY

Standard-Alarm-MI-v12